

SINGER
168W101

USE ONLY **SINGER*** OILS and LUBRICANTS

They insure freedom from lubricating trouble and give longer life to sewing equipment

The following are the correct lubricants for this machine:

TYPE B — MANUFACTURING MACHINE OIL, HEAVY GRADE

When a stainless oil is desired, use:

TYPE D — MANUFACTURING MACHINE OIL, STAINLESS, HEAVY GRADE

OTHER **SINGER** LUBRICANTS

TYPE E — STAINLESS THREAD LUBRICANT

For lubricating the needle thread of sewing machines for stitching fabrics or leather where a stainless thread lubricant is required.

TYPE F — MOTOR OIL

For oil lubricated motors and plain bearings in power tables and transmitters.

NOTE: All of the above oils are available in 1 quart, 1 gallon and 5 gallon cans or in 55 gallon drums.

GEAR LUBRICANT

This specially prepared grease is recommended for gear lubrication on manufacturing sewing machines.

BALL BEARING LUBRICANT

This pure grease is specially designed for the lubrication of ball bearings and ball thrust bearings of motors and electric transmitters, ball bearing hangers of power tables, etc. Furnished in 1 lb. and 4 lb. tins.

Copyright, U. S. A., 1914, 1915, 1916, 1922, 1924, 1925, 1926, 1934, 1935, 1937 and 1950
by The Singer Manufacturing Company
All Rights Reserved for All Countries

INSTRUCTIONS

FOR USING AND ADJUSTING

SINGER* SEWING MACHINE

168w101

POST BED

SINGLE NEEDLE

LOCK STITCH

COMPOUND FEED

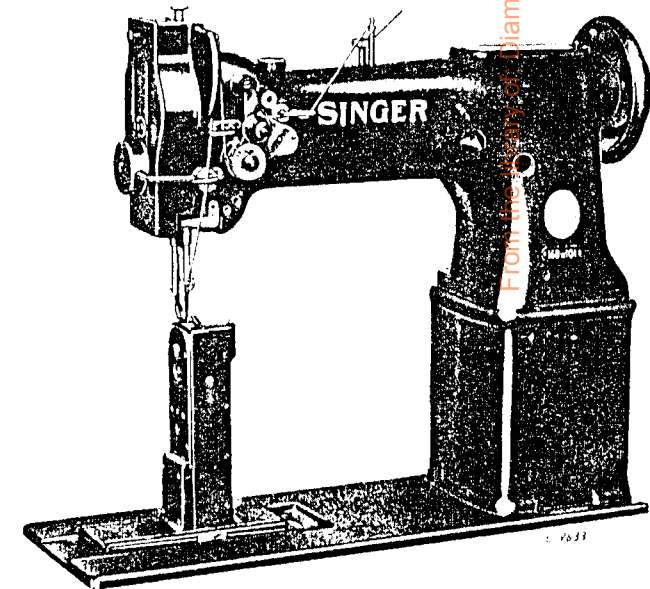

TRADE MARK OF

THE SINGER MANUFACTURING COMPANY

TO ALL WHOM IT MAY CONCERN:

The improper placing or renewal of the Trade Mark "SINGER" or any other of the Trade Marks of The Singer Manufacturing Company (all of which are duly Registered Trade Marks) on any machine that has been repaired, rebuilt, reconditioned, or altered in any way whatsoever outside a SINGER factory or an authorized SINGER agency is forbidden.

THE IMPORTANCE OF USING **SINGER** PARTS AND NEEDLES IN **SINGER** MACHINES

The successful operation of SINGER machines can only be assured if SINGER parts and needles are used. Supplies are available at all SINGER Shops for the Manufacturing Trade, and mail orders will receive prompt attention.

SINGER Needles should be used
in SINGER Machines.
These Needles and their Containers
are marked with the
Company's Trade Mark "SIMANCO.*" 1

Needles in Containers marked
"FOR SINGER MACHINES"
are NOT **SINGER** made needles. 2

DESCRIPTION

Machine 168w101 is a single needle, lock stitch, compound feed, post bed machine with alternating pressers and is especially adapted for stitching general tubular work in medium weight fabrics and leather where cross seams are encountered. It is also used for stitching in the sock lining and attaching the wrapper on California process shoes.

It has a belt driven rotary sewing hook on a vertical axis.

The compound feed consists of a needle feed and a drop feed which are simultaneously adjusted by means of an eccentric on the arm shaft to produce the desired length of stitch.

The needle bar stroke is $1\frac{3}{16}$ inches and the presser bar lift is $2\frac{1}{16}$ inch.

SPEED

The maximum speed recommended for Machine 168w101 is 2900 stitches per minute, depending on the material being stitched. The machine should be run slower than the maximum speed until the parts which are in movable contact have become glazed by their action upon each other. The balance wheel turns over toward the operator.

TO OIL THE MACHINE

When the machine is received from the factory, it should be thoroughly cleaned and oiled.

Use "TYPE B" or "TYPE D" OIL, sold only by Singer Sewing Machine Company. See inside cover for description of these oils.

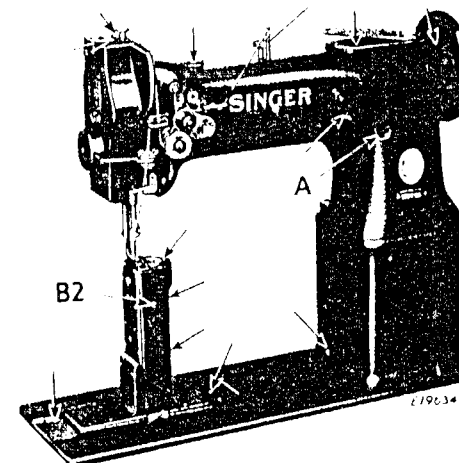

Fig. 2. Oiling Points
at Front of Machine

Oil should be applied at each of the places designated by arrows in Figs 2, 3, 4, and 5. When the machine is in continuous use, it should be oiled at least twice each day. Swing back the cover on top of the machine and oil the bearings which are thus uncovered, then replace the cover.

From the library of: Diamond Trade Corp

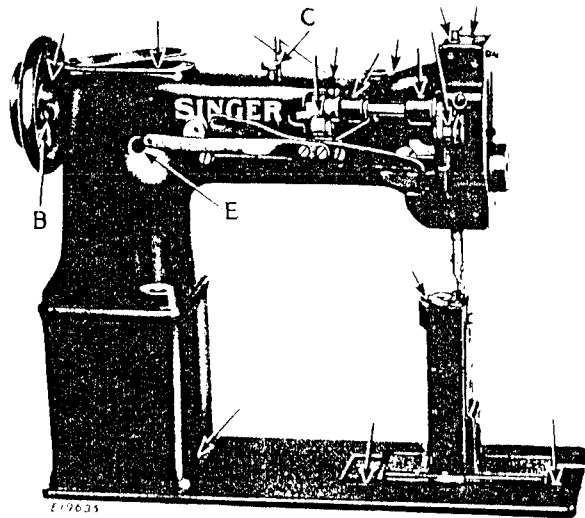

Fig. 3. Oiling Points at Rear of Machine
Also Adjustments on Machine

Turn the machine back on its hinges and apply oil at the places designated in Fig. 4.

The small felt pad on the side of the bobbin case should be kept wet with oil to lubricate the hook race.

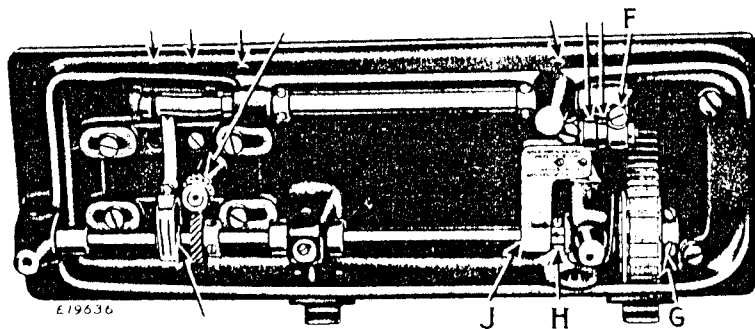

Fig. 4. Oiling Points in Base of Machine
Also Adjustments on Machine

Loosen the thumb screw in the upper end of the face plate, turn up the face plate and oil the wick and places shown by arrows in Fig. 5, then turn down the face plate and tighten the thumb screw.

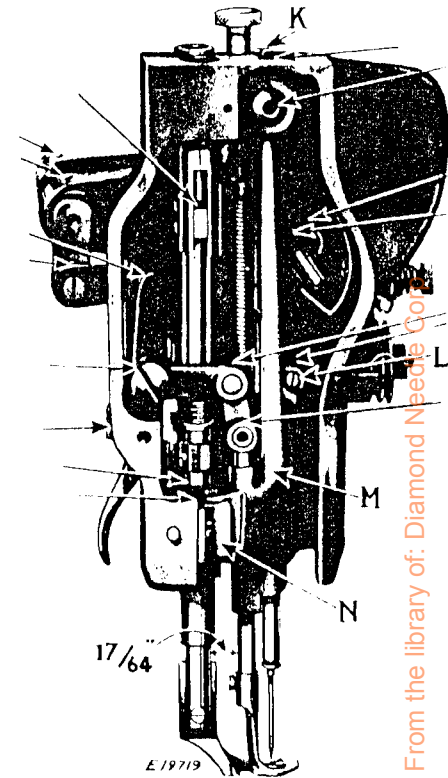

Fig. 5. End View of Machine, Showing Oiling Points
Also Adjustments on the Machine

NEEDLES

Needles for **Machine 168w101** are of Class and Variety 135 x17 and are made in sizes Nos. 9, 10, 12, 14, 16, 18, 20, 22 and 24.

The size of the needle to be used should be determined by the size of the thread which must pass freely through the eye of the needle. If rough or uneven thread is used or if it passes with difficulty through the eye of the needle, the successful use of the machine will be interfered with.

Orders for needles must specify the **quantity** required, the **size** number, also the **class** and **variety** numbers separated by an x.

The following is an example of an intelligible order:

"100 No. 14, 135x17 Needles."

The best results will be obtained in using the needles furnished by Singer Sewing Machine Company.

THREAD

Use left twist thread in the needle. Either left or right twist thread may be used for the bobbin.

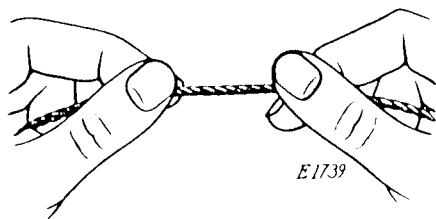

Fig. 6. How to Determine the Twist

Hold the thread as shown above. Turn the thread over toward you between the thumb and the forefinger of the right hand; if left twist, the strands will wind tighter; if right twist, the strands will unwind.

TO SET THE NEEDLE

Turn the balance wheel over toward you until the needle bar moves up to its highest point; loosen the screw at the lower end of the needle bar and put the needle up into the bar or clamp as far as it will go, with the long groove of the needle toward the left and the eye of the needle directly in line with the arm of the machine, then tighten the screw.

TO REMOVE THE BOBBIN

Draw out the slide plate on top of the post. Turn the balance wheel over toward you until the needle bar moves up to its highest point. Raise the projection **P**, Fig. 7 on the outside of the bobbin case cap, lift out the cap and remove the bobbin.

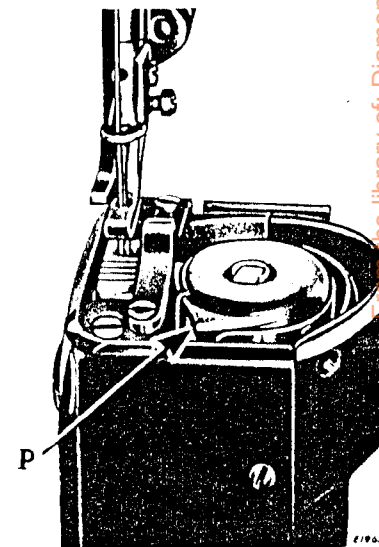

Fig. 7. To Remove the Bobbin

TO WIND THE BOBBIN

(See Fig. 8)

Fasten the bobbin winder to the table with its driving pulley in front of the machine belt, so that the pulley will drop away from the belt when sufficient thread has been wound upon the bobbin.

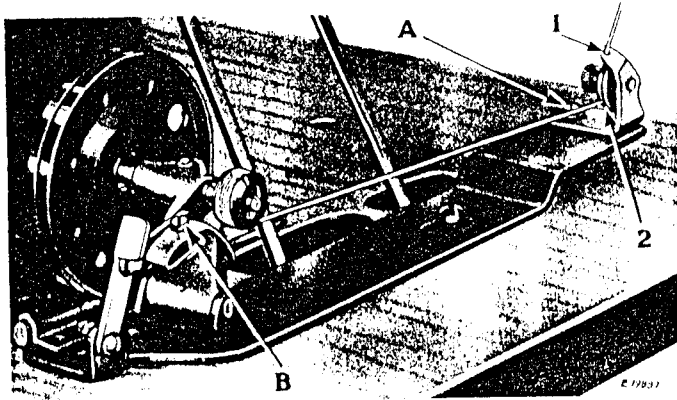

Fig. 8. Winding the Bobbin

Place the bobbin on the bobbin winder spindle and push it on as far as it will go.

Pass the thread down through the thread guide 1 in the tension bracket, around the back of, and between, the tension discs 2. Then wind the end of the thread around the bobbin a few times in the direction shown in Fig. 6, push the bobbin winder pulley over against the machine belt and start the machine.

When sufficient thread has been wound upon the bobbin, the bobbin winder will stop automatically.

If the thread does not wind evenly on the bobbin, loosen the screw A in the tension bracket and move the bracket to the right or left as may be required, then tighten the screw.

The amount of thread wound on the bobbin is regulated by the screw B. To wind more thread on the bobbin, turn the screw B inwardly. To wind less thread on the bobbin, turn this screw outwardly.

Bobbins can be wound while the machine is stitching.

When winding a bobbin with fine thread, a light tension should be used.

TO THREAD THE BOBBIN CASE CAP

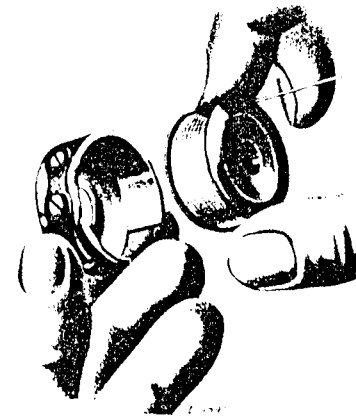

Fig. 9

Hold the bobbin between the thumb and forefinger of the right hand, the thread drawing on top from the left toward the right.

With the left hand hold the bobbin case cap as illustrated (see Fig. 9), and place the bobbin into it.



Fig. 10

Then pull the thread into the slot in the edge of the bobbin case cap (see Fig. 10), and under the tension spring as shown in Fig. 11.

To ensure the correct tension, draw the thread under the tension spring once or twice; this will remove any lint which may become lodged under the spring.



Fig. 11

TO REPLACE THE BOBBIN CASE CAP

After threading, take the bobbin case cap in the right hand, holding the bobbin in the cap with the forefinger, and place it on the center stud of the bobbin case base, then push down the latch O, Fig. 12, having the thread at the left of the projection P, as shown in Fig. 12, and replace the slide plate.

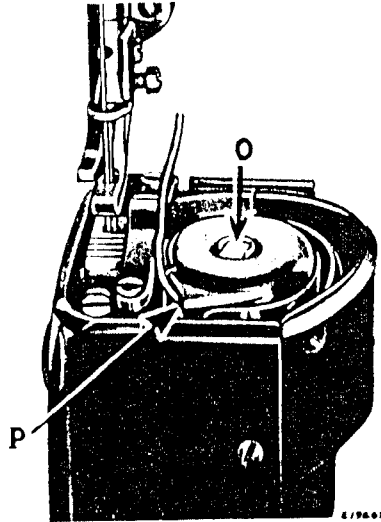

Fig. 12. Bobbin Case Cap Threaded and Replaced

UPPER THREADING

(See Fig. 13)

Pass the thread from the unwinder from back to front through the lower hole 1 in the pin on top of the machine and from right to left through the upper hole 2 in the pin, down through the hole 3, up through the hole 4 and down through the hole 5 in the thread guide at the front of the machine, over from right to left between the tension discs 6, down, under from right to left around the thread controller 7, up into the fork 8 in the thread controller disc against the pressure of the wire controller spring, up through the thread guide 9, from right to left through the hole 10 in the thread take-up lever, down through the thread guide 11, between the felt pad and felt pad retainer finger 12 and through the thread guide 13, through the thread guide 14 at the bottom of the needle bar and from left to right through the eye of the needle 15. Leave about three inches of thread with which to commence sewing.

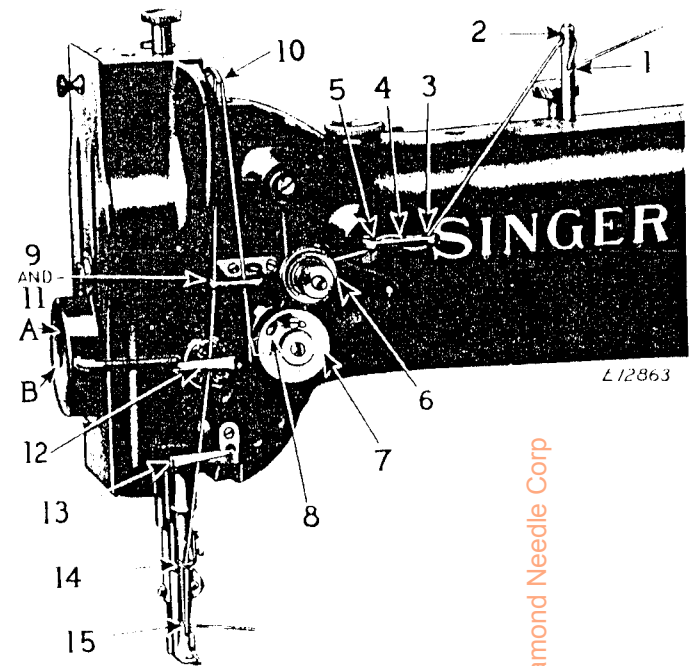

Fig. 13. Upper Threading

TO PREPARE FOR SEWING

With the left hand hold the end of the needle thread, leaving it slack from the hand to the needle, turn the balance wheel over toward you until the needle moves down and up again to its highest point, thus catching the bobbin thread; draw up the needle thread and the bobbin thread will come with it through the hole in the throat plate. Lay both threads back under the presser feet.

TO COMMENCE SEWING

Place the material beneath the presser feet, lower the presser feet and commence to sew, turning the balance wheel over toward you.

TO REMOVE THE WORK

Have the thread take-up lever at its highest point, raise the presser feet, draw the work back and cut the threads close to the goods. Lay the ends of the threads back under the presser feet.

TENSIONS

The needle and bobbin threads should be locked in the center of the thickness of the material, thus:



Fig. 14. Perfect Stitch

If the tension on the needle thread is too tight, or if that on the bobbin thread is too loose, the needle thread will lie straight along the upper surface of the material, thus:



Fig. 15. Tight Needle Thread Tension

If the tension on the bobbin thread is too tight, or if that on the needle thread is too loose, the bobbin thread will lie straight along the under side of the material, thus:



Fig. 16. Loose Needle Thread Tension

TO REGULATE THE TENSIONS

The tension on the needle thread is regulated by the thumb nut **Q**, Fig. 21 at the front of the tension discs on the front of the machine. To increase the tension, turn this thumb nut over to the right. To decrease the tension, turn the thumb nut over to the left.

The tension on the bobbin thread is regulated by means of the screw nearest the center of the tension spring on the outside of the bobbin case cap.

TO REGULATE THE PRESSURE ON THE MATERIAL

The pressure on the material is regulated by the thumb screw **C**, Fig. 3 at the top of the machine. To increase the pressure, turn the thumb screw **C** over to the right or downwardly. To decrease the pressure, turn the thumb screw **C** over to the left or upwardly.

TO ADJUST THE RELATIVE HEIGHT OF LIFT OF THE ALTERNATING PRESSERS

The amount of lift of the alternating presser feet should be regulated according to the thickness of the material being sewn. The feet should lift just high enough to clear the material. Normally, the feet should lift an equal height, but some grades of work may require that they lift an unequal

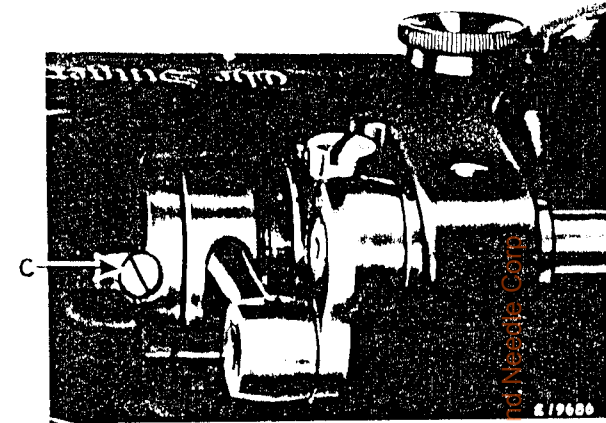

Fig. 17

height. To change the relative lift of the presser feet, loosen the set screw **C**, Fig. 17 in the lifting eccentric and turn the balance wheel so that the adjusting screw **D**, Fig. 18 is accessible. To increase the amount of lift, turn the screw **D** counter-clockwise. To decrease the amount of lift, turn the screw **D** clockwise. Then turn the balance wheel and retighten the set screw **C**.

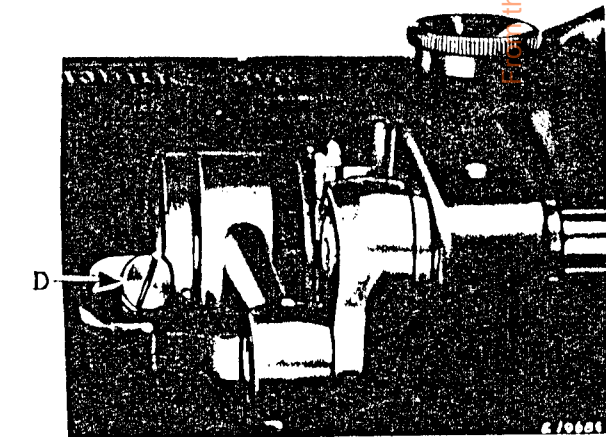

Fig. 18

TO REGULATE THE LENGTH OF STITCH

To change the length of stitch, open the arm cap, as shown in Fig. 19, loosen the set screw C2, Fig. 19 in the feed driving eccentric and turn the

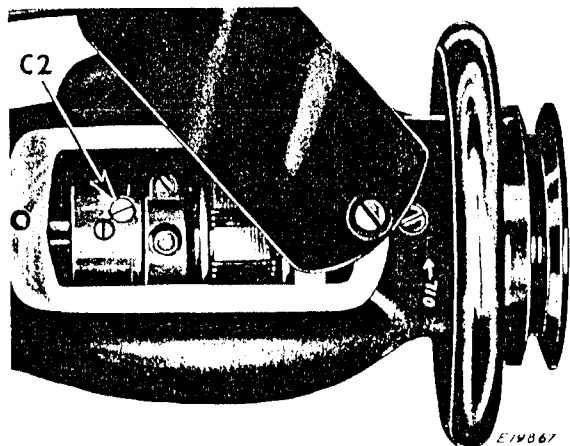

Fig. 19

balance wheel so that the adjusting screw Y, Fig. 20 is accessible. Turn the screw Y clockwise to shorten the stitch or counterclockwise to lengthen the stitch. When the desired length of stitch is obtained, tighten the set screw C2, Fig. 19.

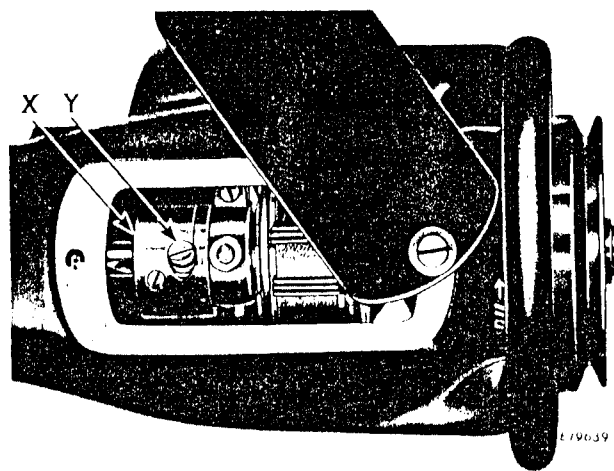

Fig. 20

INSTRUCTIONS FOR ADJUSTERS AND MACHINISTS

THREAD CONTROLLER

The function of the thread controller spring is to hold back the slack of the needle thread until the eye of the needle nearly reaches the goods in its descent, as without this controlling action of the spring, the slack thread or silk (more especially silk) will sometimes be penetrated by the point of the needle as the needle is descending.

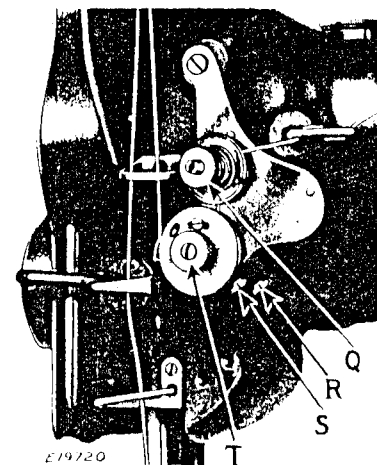

Fig. 21. Adjustments on Thread Controller

For more controller action on the thread, loosen the stop screw S, Fig. 21 at the right of the tension and set the stop lower, and for less action set the stop higher, then tighten the stop screw S.

To strengthen the action of the controller spring on the thread, loosen the tension stud screw R, Fig. 21 at the right of the stop screw and turn the tension stud T, Fig. 21 slightly to the left with a screwdriver, or to lighten its action turn to the right and tighten the tension stud screw R.

TO SET THE NEEDLE BAR

See that the needle is up in the bar as far as it will go. There are two lines across the needle bar about two inches above the lower end. When the needle bar is at its lowest position, the **upper** timing mark should be just visible at the bottom of the needle bar frame.

If the needle bar is not correctly set, loosen the needle bar connecting stud pinch screw **L**, **Fig. 5** and place the needle bar in the correct position as instructed above, then retighten the screw **L**.

To Set a Needle Bar Which Has No Mark. Set the feed eccentric **X**, **Fig. 20** for 8 stitches to the inch, then set the needle bar so that when it rises $\frac{3}{32}$ inch from its lowest position and the point of the hook is at the center of the needle, the needle eye will be about $\frac{1}{16}$ inch below the hook point.

FORWARD-AND-BACK POSITION OF NEEDLE BAR AND VIBRATING PRESSER BAR FRAME

The needle bar frame **M**, **Fig. 5** should be set so that a straight needle is centered in the needle hole in the feed dog (or slightly more toward the operator) throughout their feeding movement. It should also be set so that when the feed eccentric **X**, **Fig. 20** is set for zero feeding movement, the distance between the vibrating presser bar and the lifting presser bar will be $\frac{13}{64}$ inch, as shown in **Fig. 5**.

If the needle bar is not centered correctly in the needle hole in the feed dog, adjust the feed eccentric for zero feeding movement, then loosen the clamp screw **F**, **Fig. 4** in the crank and also loosen the screw reached through the hole **E**, **Fig. 3** in the rear of the arm; center the needle with the feed dog and see that the crank at **F**, **Fig. 4** is parallel with the top surface of the bed before tightening the two clamp screws.

If the vibrating presser bar is now the incorrect distance from the lifting presser bar, with zero feeding movement, loosen the clamp screw at **E**, **Fig. 3** and set the bars $\frac{13}{64}$ inch apart, then tighten the screw at **E**. A piece of sheet metal $\frac{13}{64}$ inch wide may be used as a gauge for determining the correct distance.

TO TIME THE SEWING HOOK

Set the feed eccentric **X**, **Fig. 20** so that there is no feeding movement.

Remove the throat plate and turn the balance wheel over toward you until the **lower** timing mark across the needle bar is just visible at the bottom of the needle bar frame on the upward stroke of the needle bar. If the needle bar and sewing hook are correctly timed, the point of the hook will be at the center of the needle and about $\frac{1}{16}$ inch above the eye.

If the sewing hook is not correctly timed, turn the balance wheel over toward you until the needle bar has descended to its lowest point and has risen until the **lower** timing mark across the needle bar is just visible at the bottom of the needle bar frame.

Loosen the two screws **V**, **Fig. 22** in the hook shaft gear and turn the sewing hook until its point is at the center of the needle as instructed above. Then securely tighten the two screws **V**.

TO SET THE SEWING HOOK TO OR FROM THE NEEDLE

To prevent the point of the hook from dividing the strands of the threads, it should run as close to the needle (within the scarf) as possible.

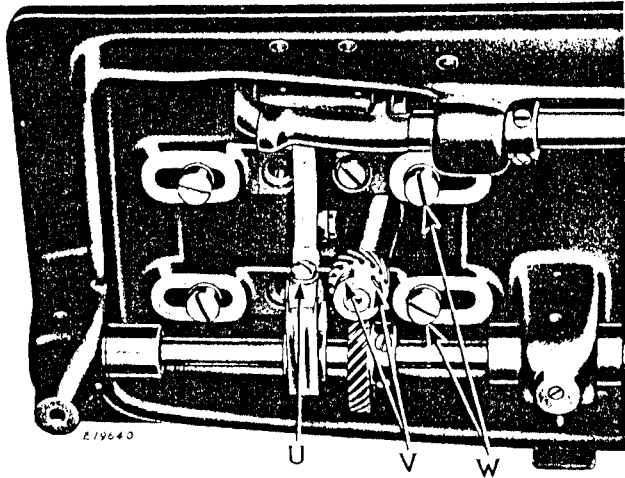

Fig. 22. Adjustment of Hook Saddle

Turn the balance wheel over toward you until the point of the sewing hook is at the center of the needle. Loosen the screw **B2**, Fig. 2 on the face of the post and the two screws **W**, Fig. 22 underneath the bed of the machine and move the hook saddle to the right or left, as may be required, until the point of the hook is as close to the needle as possible without striking it, then securely tighten the two screws **W** and the support screw **B2**.

NEEDLE GUARD

The needle guard, which is attached to the bottom of the sewing hook, should stand out far enough to prevent the point of the hook from striking the needle, but not far enough to prevent the hook from catching the thread loop.

Bend the needle guard slightly to adjust it.

TO REMOVE THE SEWING HOOK FROM THE MACHINE

Remove the slide plate, throat plate, feed dog and the bobbin case opening lever **Z**, Fig. 25. Remove the two gib screws at the heel of the hook and move the gib aside to allow the bobbin case base to be taken out, after which remove the screw, shown in Fig. 23, from the center of the hook.

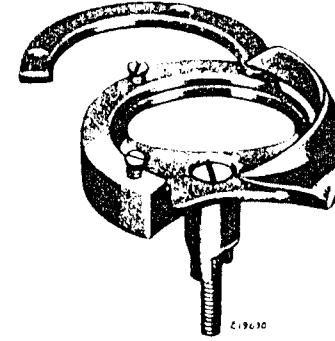

Fig. 23. Sewing Hook

Tapping the hook slightly on the bottom of its rim will force it from its socket. Do not try to pry it out, as prying may bend the shank of the hook.

When replacing the hook, be sure that the prongs of the shank enter the slot at the bottom of the socket correctly, otherwise the hook will be out of time.

TO RAISE OR LOWER THE FEED DOG

Usually when the feed dog is at its highest position, it should show a full tooth above the throat plate.

Remove the throat plate; clean the lint and dirt from between the feed points and replace the throat plate; tip the machine back and turn the balance wheel over toward you until the feed dog is at its highest position, then loosen screw **U**, Fig. 22 in the feed lifting cam fork and raise or lower the feed dog as may be required, then tighten the screw **U**.

When raising or lowering the feed dog be careful to see that it is not set low enough to strike the sewing hook.

TO REMOVE THE NEEDLE BAR ROCK FRAME ROCK SHAFT

Remove the face plate and the bracket **L**, Fig. 5, loosen the hinge stud set screw **K**, Fig. 5 and remove the rock frame **M**, Fig. 5, then loosen the clamp screw at **A**, Fig. 2 and draw out the rock shaft.

TO REMOVE AND REPLACE THE ARM SHAFT CONNECTION BELT

Remove the balance wheel, then loosen the screw **B**, Fig. 3 at the rear of the machine, which holds the arm shaft bushing. The bushing can then be removed from the machine. Remove the belt from the lower pulley, then lift the belt up through the arm cap hole as far as possible and draw it out through the space normally occupied by the arm shaft bushing.

Owing to the fact that the sewing hook makes two revolutions to one revolution of the arm shaft and the hook driving shaft and that the feed lifting eccentric is mounted on the hook driving shaft, it is possible to have the sewing hook correctly timed without having the feed eccentric correctly timed. To overcome this, the plate **J**, Fig. 4, attached to the underside of the bed, is marked with an arrow and the collar **H**, Fig. 4 on the hook driving shaft is also marked with an arrow.

After replacing the belt over the arm shaft, replace the arm shaft bushing and securely fasten it in position by the screw **B**, Fig. 3; replace the balance wheel, place the belt on the upper pulley and turn the balance wheel over toward you until the thread take-up lever is at its highest point, then turn the hook driving shaft with the fingers until the arrow on the collar **H**, Fig. 4 is directly in line with the arrow on the plate **J**, Fig. 4. Now, without disturbing either the arm shaft or the hook shaft, slip the belt over the lower pulley, as shown in Fig. 24. The feed will then be correctly timed with the needle bar.

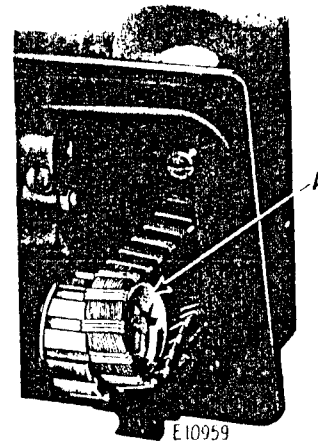

Fig. 24. Putting Belt on Lower Pulley with Belt Replacer 265058

To facilitate the replacing of the belt on the lower pulley, use Belt Replacer 265058 **A**, Fig. 24. Rest the replacer in the loop of the belt, as shown in Fig. 24, having the notches in the replacer engage the two set screws in the hub of the pulley. Turn the balance wheel over toward you until the belt is fully over the pulley, then remove the replacer.

NOTE: As Belt Replacer 265058 will serve for several machines, it is not regularly furnished with the machine and must be ordered separately.

TO ADJUST THE MECHANICAL OPENER

Remove the cover plate at the front of the hook post, being careful not to damage the gasket.

The bobbin case lever **Z**, Fig. 25 at the left of the sewing hook, actuated by the eccentric on the hook shaft, strikes the projection on the bobbin case and turns the bobbin case slightly, making an opening between the bobbin case stop and the stop on the throat plate when the thread is across the bobbin case and passing between the stops.

The bobbin case lever **Z** may be adjusted by loosening the two bobbin case lever screws **A2**, Fig. 25 and moving the bobbin case lever forward or backward.

This adjustment should be made so that the opening between the lever and the projection on the bobbin case is just perceptible when the bobbin case lever has opened the bobbin case all the way.

If the bobbin case lever is set to open the bobbin case too far, it will cause binding between the bobbin case bearing and the hook bearing when the bobbin case is opened all the way, and care must be taken to see that this does not occur. After the correct adjustment is made, firmly tighten the screws **A2**, Fig. 25.

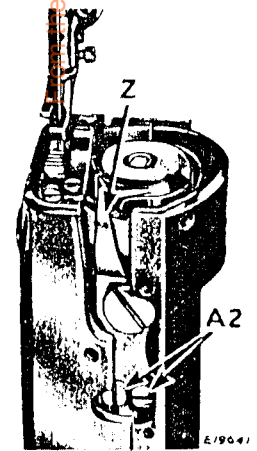

Fig. 25. Adjustment of Mechanical Opener